



CLICKFORM™

Fascia and Gutter System

THE FASCIA AND GUTTER SYSTEM FOR THE FUTURE

NEW INNOVATIVE DESIGN

The Clickform™ Fascia and Gutter System is a combination of the best available materials combining both the strength of steel and the latest in plastics technology.



CONSISTENT QUALITY

Unlike timber you will not experience warping, bowing, knots or cracking. Instead you will receive a consistent, trouble free

product, without the variability of price and quality, often found with timber.

FLEXIBLE

The Fascia and Gutter of the Clickform™ system has free horizontal movement, allowing uniform expansion and contraction.

FAST, EFFICIENT INSTALLATION

Stratco has a network of experienced installers who provide quality installation in the minimum amount of time.

This ensures that you have selected the best material and the best tradespeople for your project.

PRICED RIGHT

Steel and Plastic are not subject to large price fluctuations caused by uncertain supply.

GUTTERS EASILY ADJUSTED

The Clickform™ Gutter System has been designed to allow for gutter fall, using the Award Winning Clickfast® Suspension Clip.

OVERFLOW PROTECTION

The Eaves gutter can be produced with a slotted face which overflows prior to the gutter completely filling. This prevents damage to ceilings and inside structures.

EXTRA STRENGTH

Lighter and tougher fascia and external gutter profiles utilise hi-tensile steel for greater on site strength.

COMPONENTS OF THE CLICKFORM™ FASCIA GUTTER SYSTEM

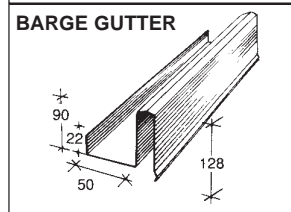
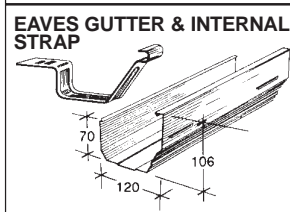
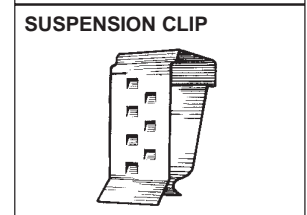
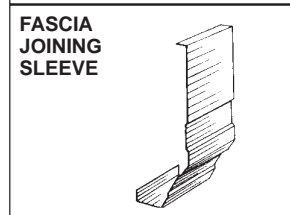
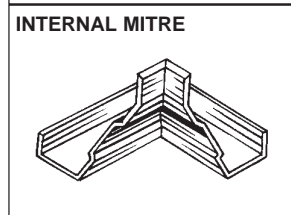
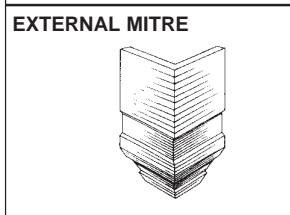
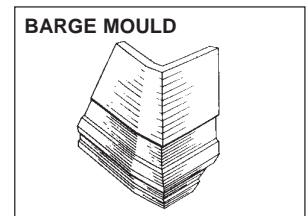
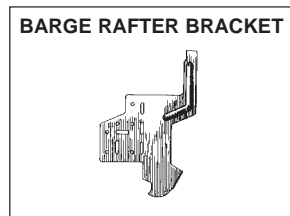
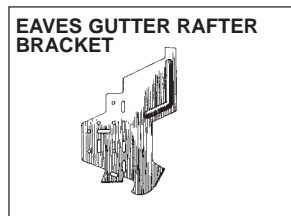
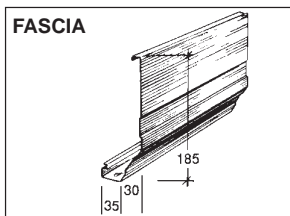

When ordering ensure either **Clickform™** or **Clickfast®** components are clearly specified. Barge moulds should be specified left or right hand when ordering.

MAJOR GUTTER PROFILES

EAVES GUTTER

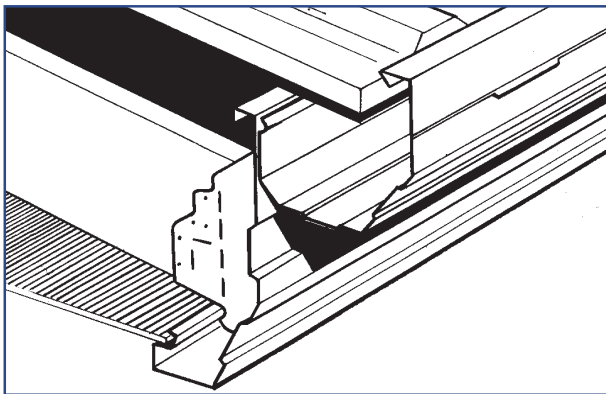

COLOUR OPTIONS

Zincalume:

Stratco Clickform™ fascia is available in Zincalume, allowing you to select a colour to match your outdoor decor.

Colour:

For those who do not wish to paint, a wide range of pre-painted colours is available.

IMPORTANT: Consult your nearest Stratco office for availability in your region.

INSTALLATION OF THE CLICKFORM™ FASCIA AND GUTTER SYSTEM

1 EAVES CONSTRUCTION

The Clickform™ Fascia and Gutter System is completely compatible with normal building construction. It complements both steel or tiled roofs and this means that accurate cutting of rafter ends is no longer required.

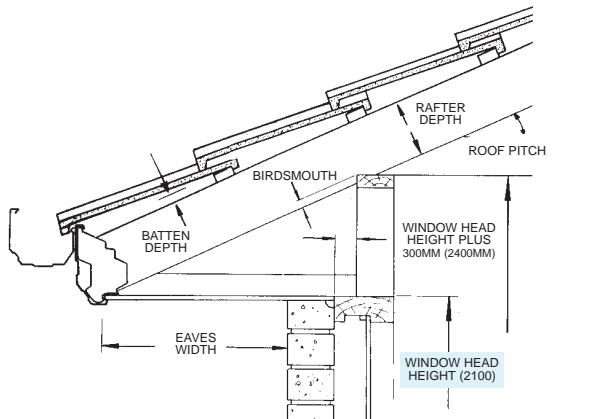

2 FINISHING OFF

Internal and external fascia mitres have been included for ease of installation and a superior finish. Joining two lengths of fascia together is easily achieved by using a joining sleeve. Mitres and joining sleeves are simply riveted to the fascia.

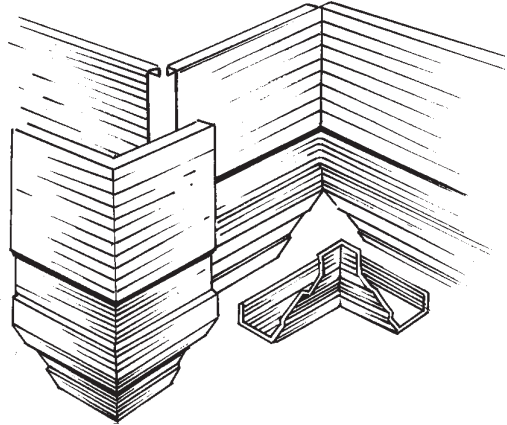

3 SIMPLE STEEL BARGES

Now the simple elegant lines of your fascia can continue up the barges providing a consistent look all round the house. The junction between fascia and barge is easily completed using a Barge Mould.

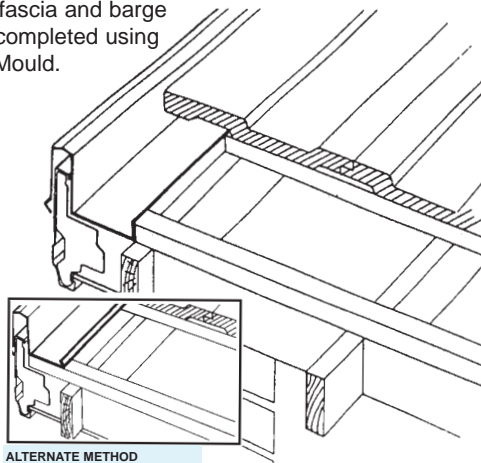

AUSTRALIAN STANDARDS

The Clickform™ Fascia and Gutter System was designed to comply with Australian Standards AS2180-1986 "Metal Rainwater Goods - Selection & Installation". This standard requires that eaves gutters receive a minimum 1 in 500 fall. Rebate metal fascias are often unable to comply, without complex structural alterations and systems where brackets rivetted to the fascia reduce flexibility.

The Clickform™ system is the next generation Fascia and Gutter system born out of Stratco's **award winning** and very successful Clickfast® system.