











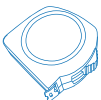
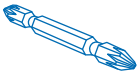
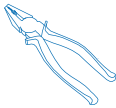

## Roofcap™ Batten

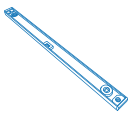

### BEFORE YOU START

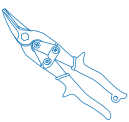
Check that all the components on the order have been delivered. Ensure the current roof structure is free of debris and is safe to traverse. It is the builder's responsibility to ensure the existing structure is capable of withstanding the additional loads imposed by the new steel roof.

### TOOLS REQUIRED

						
Ladder	Drill Bit	Tape Measure	Phillips Head Adapter	Pliers	Angle Grinder	Spirit Level
						
Power Drill	Hex Head Adapter	Permanent Marker	Tin Snips	Gloves	String Line	Safety Glasses



## STRATCO ROOFCAP BATTENS

The Stratco Roofcap Batten System is an economical alternative to replacing roof cladding without having to remove the existing cladding.

Manufactured from hi-tensile galvanised steel, the battens remain straight and consistent throughout their long life.

The profile of the batten allows for nesting, making them easy to store, carry and handle.

Stratco Roofcap Battens are versatile and easy to use. Manufactured in approximately 3.0m lengths the battens can be lapped to allow for cladding creep during installation.

They are compatible with many different roof cladding profiles and are fixed through the existing cladding into the purlins. The new roof cladding is then fixed to the battens.

Three different batten heights allow for the different roof profiles and insulation thickness.

## SPECIFICATIONS

Manufactured from hi-tensile galvanised steel, Stratco Roofcap Battens with their applicable roof cladding profile or equivalent comply with the testing requirements set out in AS1562.1-1992 and AS4040.0, 1&2-1992. Wind pressures are determined in accordance with AS4055-2006 for domestic applications and AS/NZS1170.2:2011 for all other applications. Refer to wind capacity tables on the Stratco website for allowable spans. Roofcap Battens are to be used in non-cyclonic regions only.

Base Metal Thickness	1.2mm
Yield Strength	550 MPa
Coating Mass	275 g/m <sup>2</sup>

EXISTING ROOF CLADDING PROFILE	INSULATION THICKNESS	DIMENSION 'A'	DIMENSION 'B'	NO. OF SCREWS PER MOUNTING FLANGE
TOPDEK® 700 or equivalent	75 mm	62 mm	75 mm	1
	55 mm	82 mm	55 mm	1
PRODEK® or equivalent	75 mm	62 mm	75 mm	1
SUPERDEK® or equivalent	75 mm	67 mm	70 mm	2
	55 mm	67 mm	50 mm	2
	NO INSULATION	67 mm	40 mm	2
SMARTSPAN® or equivalent	75 mm	62 mm	75 mm	1
	55 mm	62 mm	55 mm	1
	NO INSULATION	62 mm	45 mm	1
CGI	75 mm	62 mm	75 mm	1
	55 mm	52 mm	55 mm	1
	NO INSULATION	71 mm	36 mm	1

Table 1

**Note:** Batten spacing must not exceed the maximum recommended roof cladding spans for the new roof. The new roof cladding profile must have the same minimum span as the existing cladding. Battens are to be fastened through to the existing roof cladding and into the timber or steel roof purlins.

# INSTALLATION

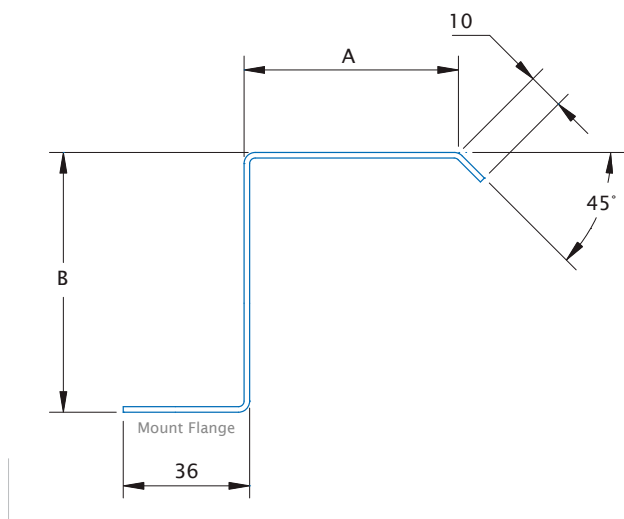

Figure 1

Place the first batten, at the roof edge, over the top of the existing roof cladding and have the mount flange central over the top of the purlin (Figure 2). Make sure the batten's mount flange is sitting down flat in every valley of the existing roof profile.

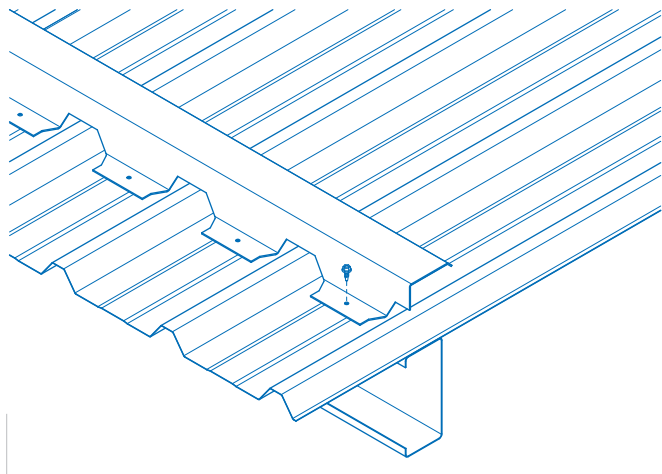

Figure 2

Fasten the batten in place with 12x20mm hex-head self drilling screws on every mount flange for steel purlins or 12 gauge timber fixing screws at minimum 35mm embedment for timber supports. Refer to the 'Specifications Table' for the number of screws per mount flange.

The next batten is to be placed with at least one mount flange overlap (Figure 3), making sure the next batten sits down flat in the existing roof cladding valleys.

The battens are made in approximately 3.0m lengths to allow for cladding creep along the width of the roof. If the batten does not sit flat in the valley, cut the battens into shorter lengths to allow for the excess creep.

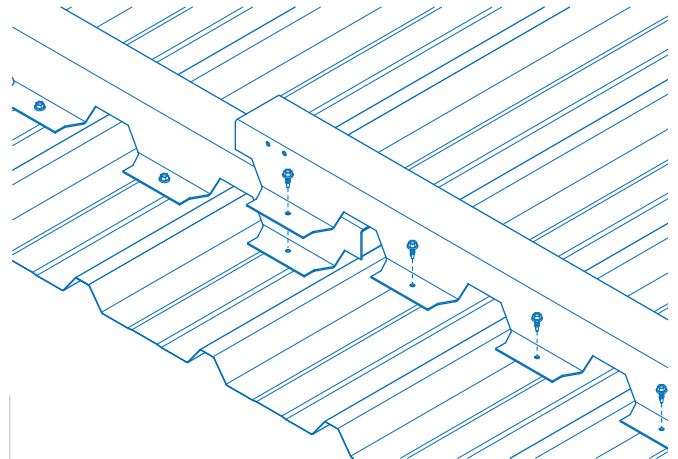

Figure 3

Each overlap requires a minimum of two 12x20mm hex-head self drilling screws if being fastened through the side face of the batten (Figure 4). If the pilot holes for the overlap are on the top face of the batten, a minimum of two 12x20 wafer head self drilling screws are to be used.

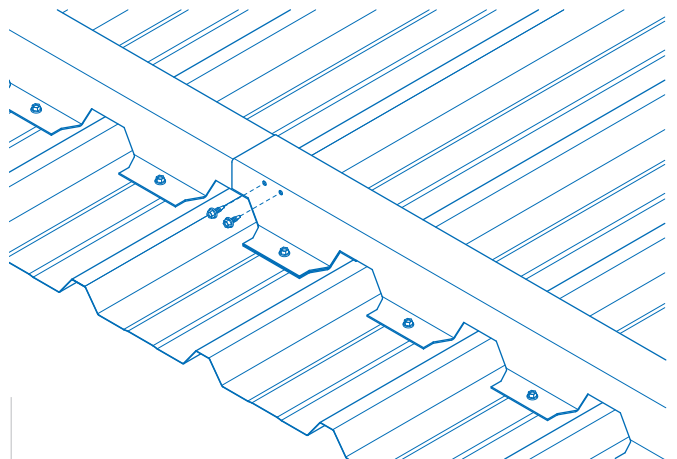

Figure 4

Insulation can be laid over the top of the battens. It will be squashed down when the roof sheets are installed. Always use insulation specifically designed with anti condensation properties and install as per the manufacturer's directions.

Fasten the roof sheets to the batten as per the appropriate Stratco roof specifications.

When using the Roofcap Battens to install a new roof it is recommended that the builder follows the Installation Guide for each of the roofing profiles regarding traversing the roof. This information can be found on the Stratco website.

## ADDITIONAL INFORMATION

In some situations a top hat or equivalent will be required to support the end of the new roof sheet and any required flashings.

When installing a skylight, a flashing must be used to cover the exposed edge of the old roof sheet and cavity. The flashing will require notching over the Roofcap Batten.

The old gutter may need to be replaced with a high front gutter as a result of the height of the roof being altered, due to the addition of the Roofcap Battens and new roof sheets.

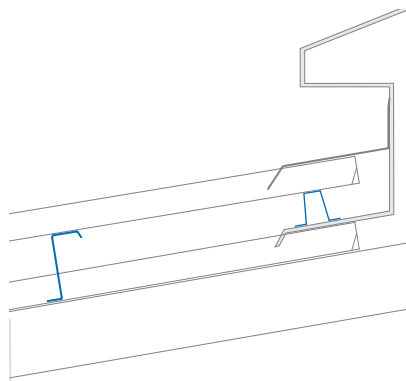

Ventridge Example

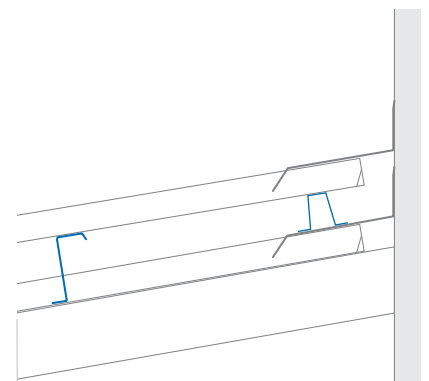

Parapet Wall Example

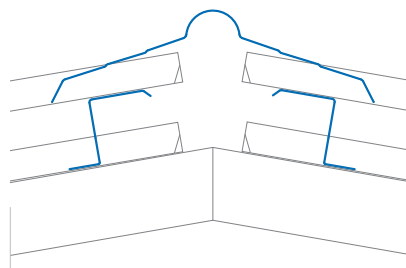

Ridgecap Example

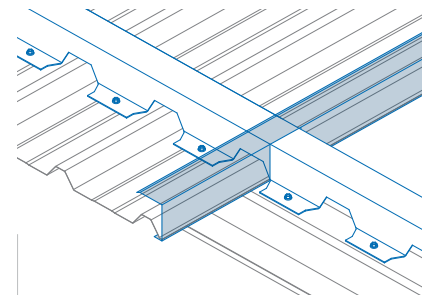

Skylight Flashing Example

It is the builder's responsibility to ensure that the existing roof structure is capable of withstanding the installation loads and the additional loads imposed by the new steel roof and any flashings required to complete the re-cladding process.

## MAINTENANCE

Maintenance should be performed as often as is required to remove any dirt, salt and pollutants. Where used in severely corrosive environments, cleaning should be performed more often. It is important that screws have the same life expectancy as the cladding you have specified.

Packs of Roofcap Battens should always be kept dry and stored above ground level while on site. If the sheets have become wet, they should be separated, wiped and placed in the open to dry.

Refer to the Stratco "Selection, Use and Maintenance" brochure, for more detailed information about the correct use and maintenance of this product.