



**THANK YOU FOR PURCHASING YOUR 2 DOOR METAL LOCKER UNIT.**

Please carefully read and follow these instructions to assemble your cabinet.

ENSURE PROTECTIVE EYEWEAR AND GLOVES ARE WORN WHEN ASSEMBLING THIS UNIT.

## Step 1

### FITTING SIDE PANELS TO BACK PANEL

(A)

Screw together back panel and left hand side panel at locations indicated by the arrows.

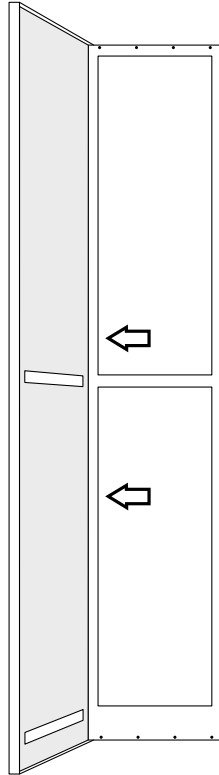

(B)

Screw together back panel and right hand side panel at locations indicated by the arrows.

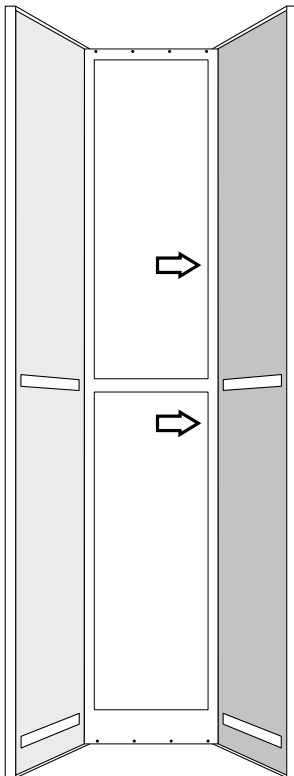

## Step 2

### FITTING FRONT DOOR PANEL TO SIDE PANELS

(C)

Slot front door panel into one side then into the other.

Note: Ensure the front door panel is flush with the side panels. This is easier to do with the doors open.

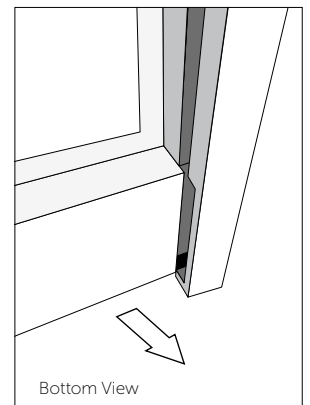
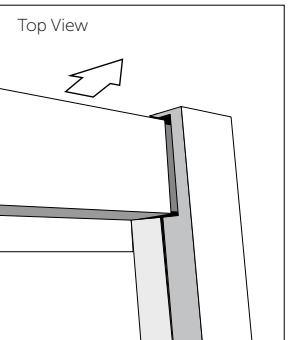
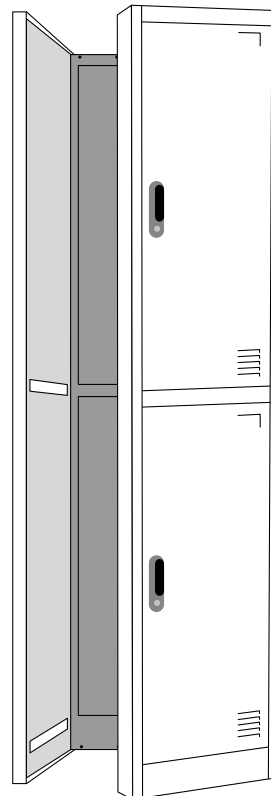
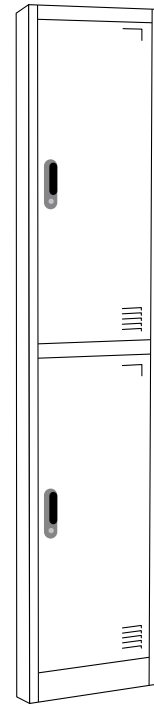

## Step 3

### FITTING THE TOP PANEL

**D** Slide the top panel inside the cabinet and push up until flush with the top of panels.

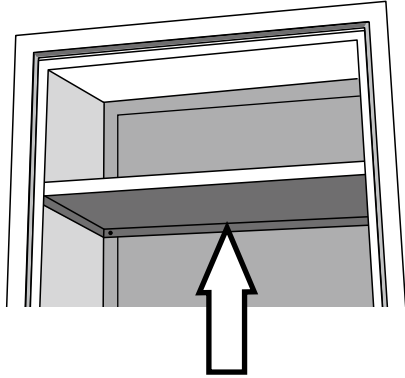

**E** Screw the top panel to the inside of the cabinet as indicated by the arrows.

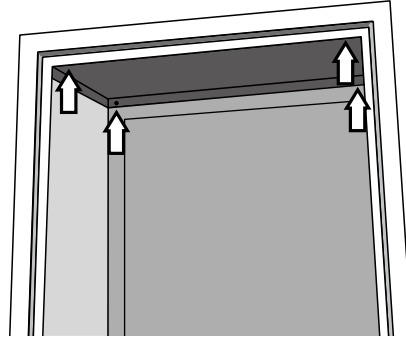

## Step 4

### FITTING THE BOTTOM PANEL TO THE CABINET

**F** Push the floor panel down inside the cabinet ensuring the sides of the floor slide into the slots on the side and back panels.

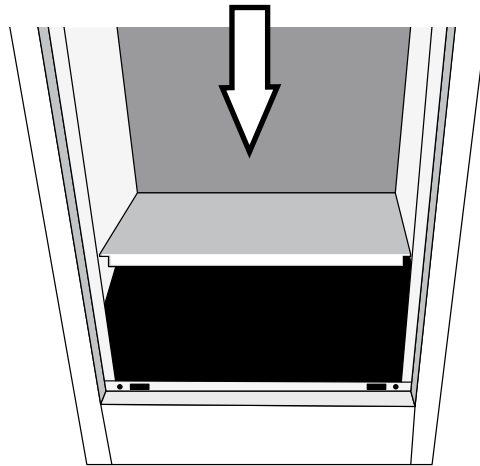

**G** Ensure that the tab on the bottom panel fits over the lip on the front panel and clips into place.

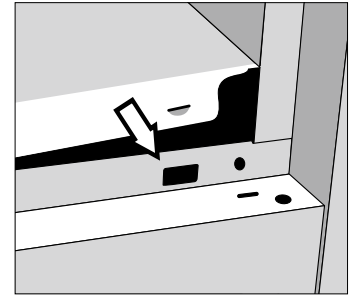

## Step 5

### FITTING THE LOCKER BASE PANEL

**H** Insert the locker base panels from the inside of the cabinet.

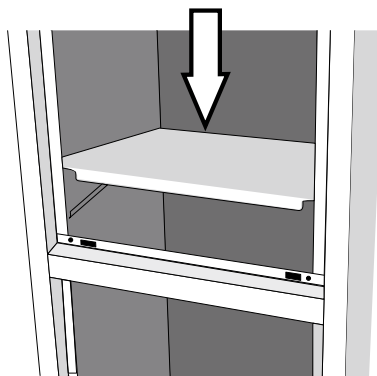

**I** Ensure that the tab on the locker base panel fits over the lip on the front panel and clips into place.

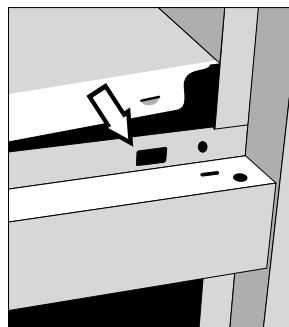

Finished size:  
1850 x 380 x 450mm

